

Ferrite Plate Cores (FP Series)

Description :

Ferrite Plate core (FP series) is one EMI suppression core with flat plate shape. It can suppress radiation noise from microprocessor when attached on the microprocessor, prevent resonance and suppress coupling when attached two microprocessors, suppress the electromagnetic noise through the cable from electric equipments when attached on the flat cable like FFC (Flexible Flat Cable) or FPC (Flex Printed Circuit). Also, it can avoid the NFC (Near Field Communication) mobile phone performance reduced because the battery, and restrict the magnetic fields occurred respectively from wireless charger base station and mobile device to protect others equipment.

Applications :

- NFC (Near field communication)
- Wireless Charger
- Suppress radiation noise from microprocessor.
- Prevent resonance between two microprocessors.
- Suppress radiation noise from cable to compliance with FCC, VDE and VCCI.

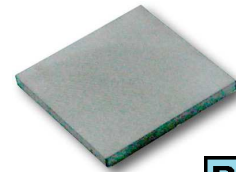

RoHS 2.0
2011/65/EU

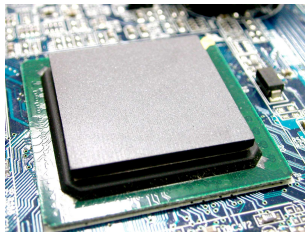

EX1 : put on microprocessor

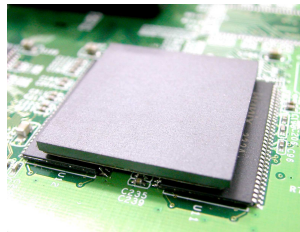

EX2 : between two microprocessors

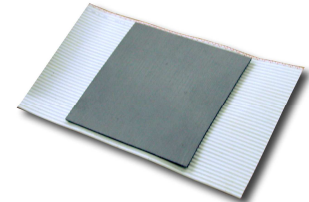

EX3 : apply on the flat cable

Part Number	Wide (mm)	Length (mm)	thickness(mm)
FP 10 x 10 x 1.0 - G	10	10	1.0
FP 20 x 20 x 1.5 - G	20	20	1.5
FP 30 x 30 x 1.5 - G	30	30	1.5
FP 35.5 x 13.9 x 1.0 - G	35.5	13.9	1.0
FP 35.5 x 13.9 x 1.6 - G	35.5	13.9	1.6

Note : We're welcome your inquiry if your dimension is not listed.

Filter Effect Test :

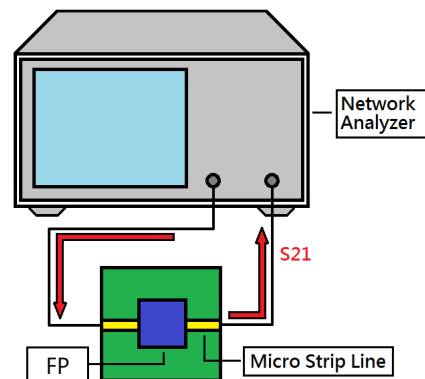
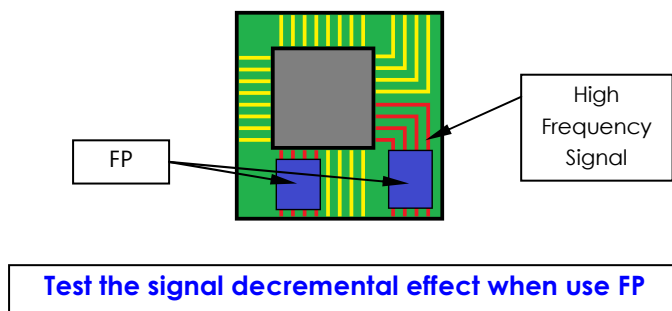

Ferrite Plate Cores (FP Series)

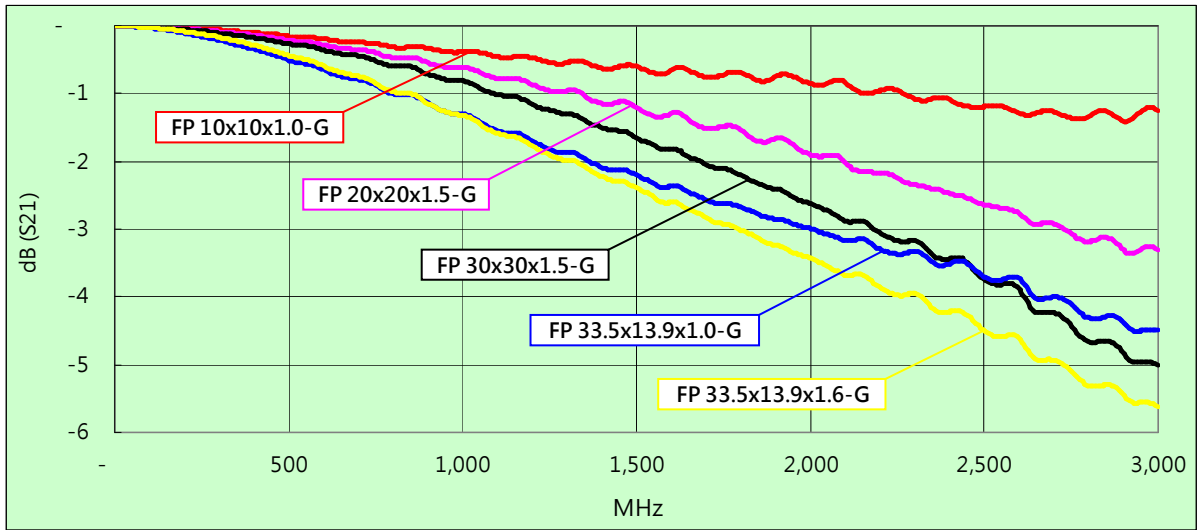

Magnetic Shield / Decoupling Effect Test :

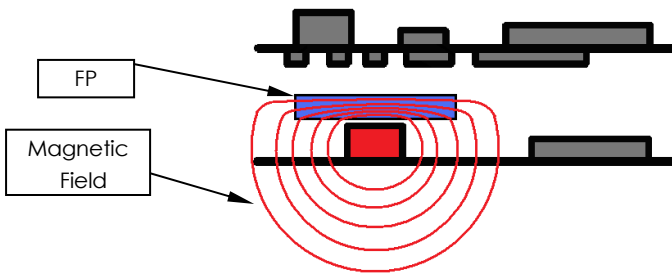

Test the magnetic field reduction effect when use FP

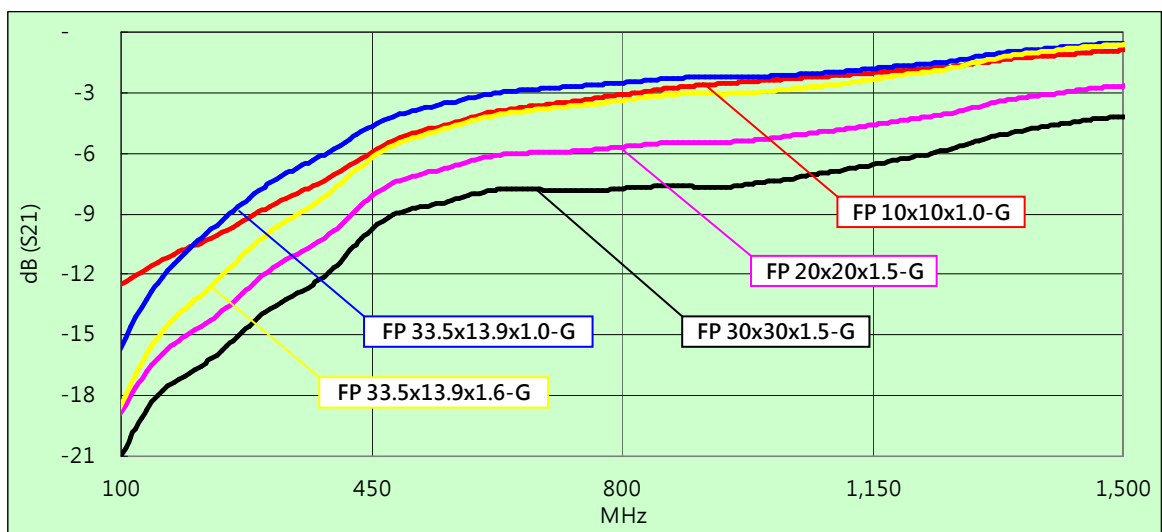
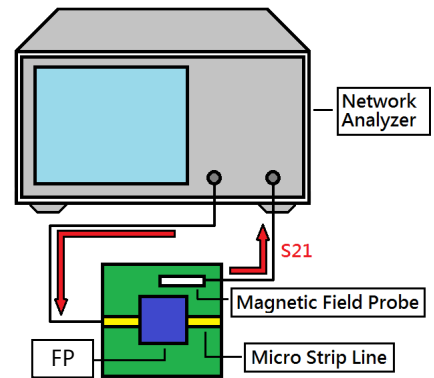

● Above test data is only for reference, not for specification data.